



## VHX-67F-MUS

Dakota Digital VHX Instrument Installation  
For 1967-'68 Ford Mustang

Your new VHX-67F-MUS kit includes:



## Installation

1. Remove the stock gauges from the dash (save this hardware). Remove the nine (9) screws holding the gauges to the bezel on the back of the system, and the two (2) screws that secure the wiper switch. The wiper switch will be reused when the Dakota Digital system is in place.

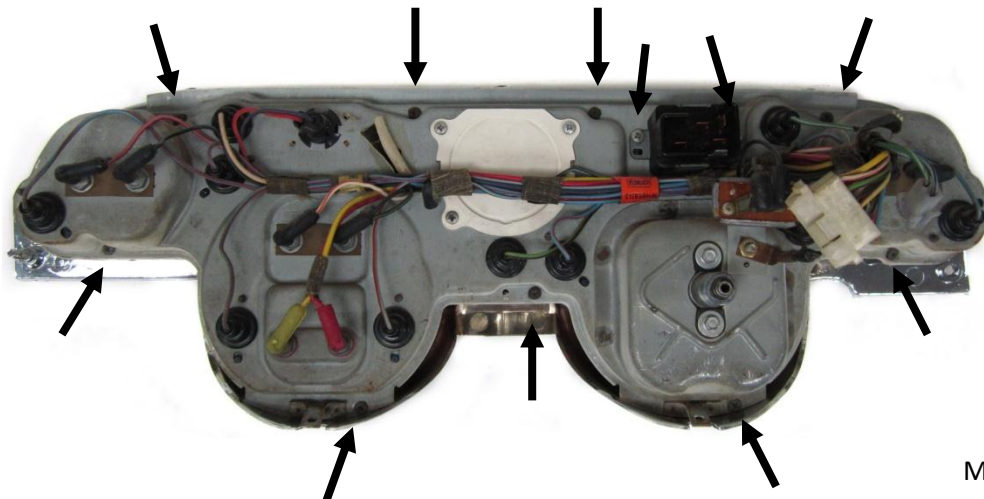

2. If you are using the existing bezel, remove the stock gauges, separator plates, and lenses from the bezel. The only item to be reused is the original front bezel. This instrument system is compatible with new reproduction bezels; now is a good time to clean your stock bezel or upgrade to a new one.

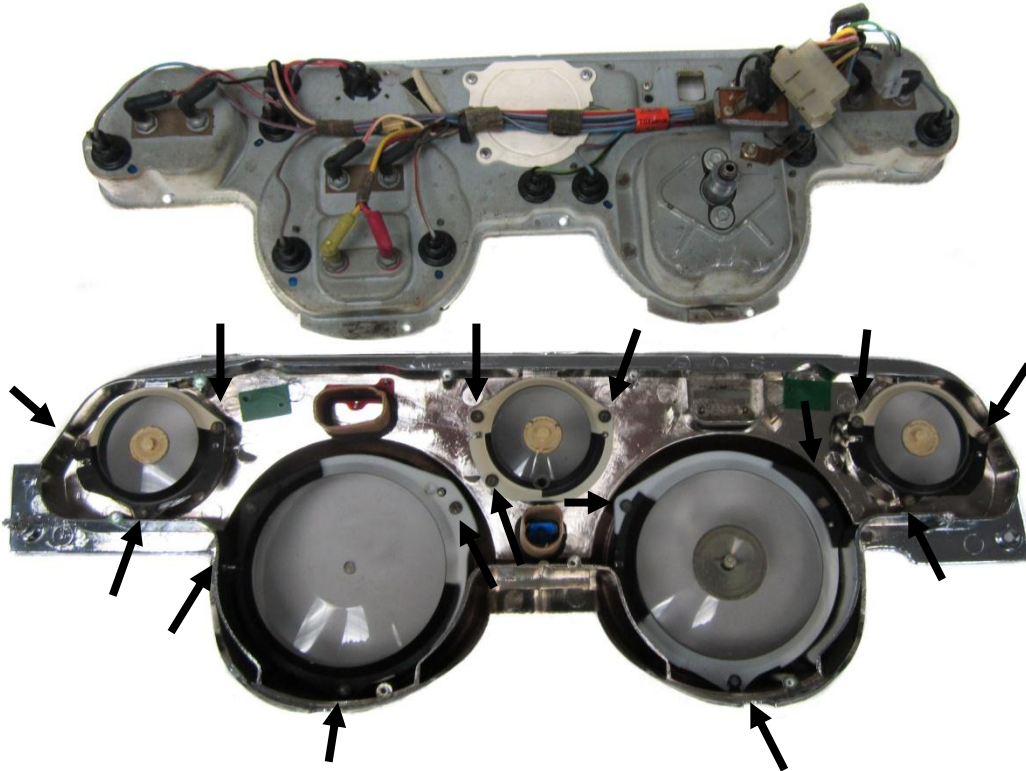

3. You will be left with a bare bezel, containing only the turn signal indicator lenses.





4. The stock indicators for Brake and High Beam will not be used. Two, small, block-off plates are included; these carry engraved part numbers, 636108 and 636109, for Brake and High Beam respectively. RTV silicone works well to secure these plates. Be sure to glue the pieces with the textured side down to ensure the part numbers are not visible from the front side.

5a. Place the gauges in the bezel and orientate each gauge to ensure they are properly aligned.



5b. Use the provided 2" screws with lock washers and mount the gauges in place. Do not fully tighten; the holes are slotted to allow minor adjustments to perfectly align each gauge. For the Speedometer and Tachometer, use the two provided brackets at the bottom slots as shown (white arrows). Once aligned, finish tightening the 12 screws using care as to not strip the threads.

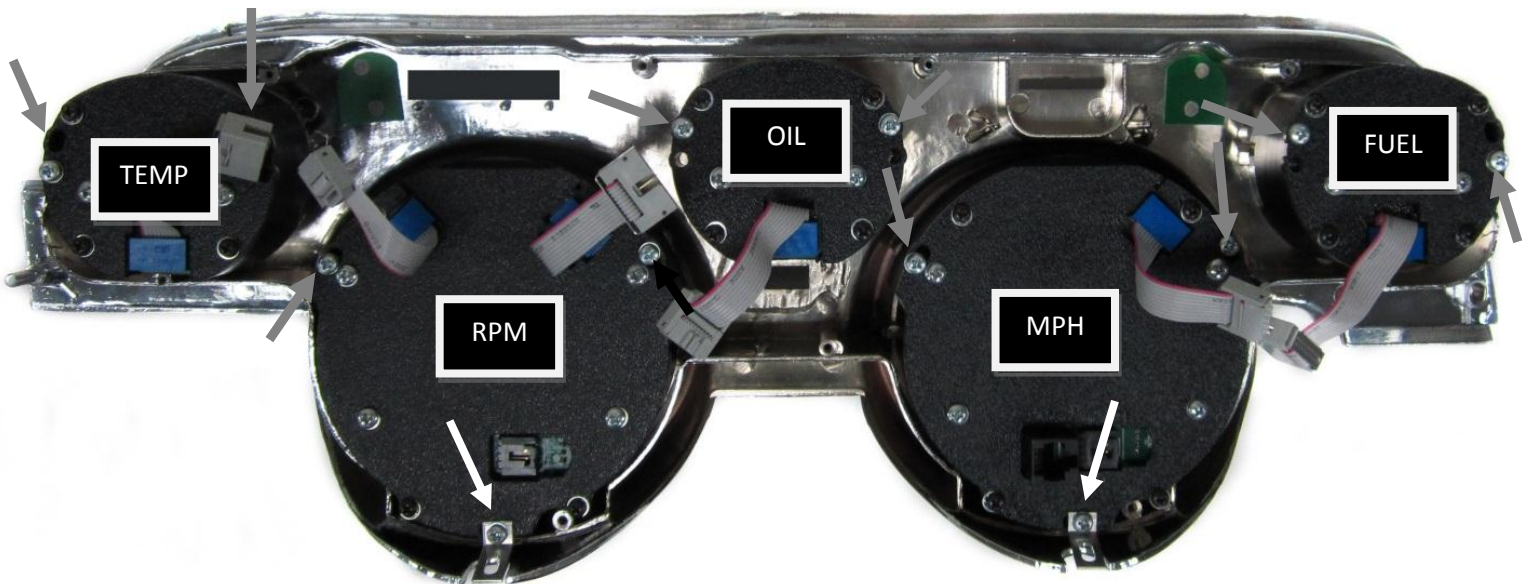

6. The cluster should look as shown starting from the left FUEL, MPH, OIL, RPM, TEMP.



7. Mount the Wiper switch to the ABS plastic panel with the smooth side facing you. The Wiper switch will fit into the large cross hair, and the arm of the switch will slide through the ABS from the rear. Use the provided 3/8" screws with lock washers and nuts to mount the wiper switch to the panel.

8. Lay the ABS panel over the back of the gauge cluster with the smooth side down and slip the wiper arm through the appropriate opening in the bezel. Use the seven (7) supplied 1/2" black screws with lock washers to mount the panel to the back of the bezel.

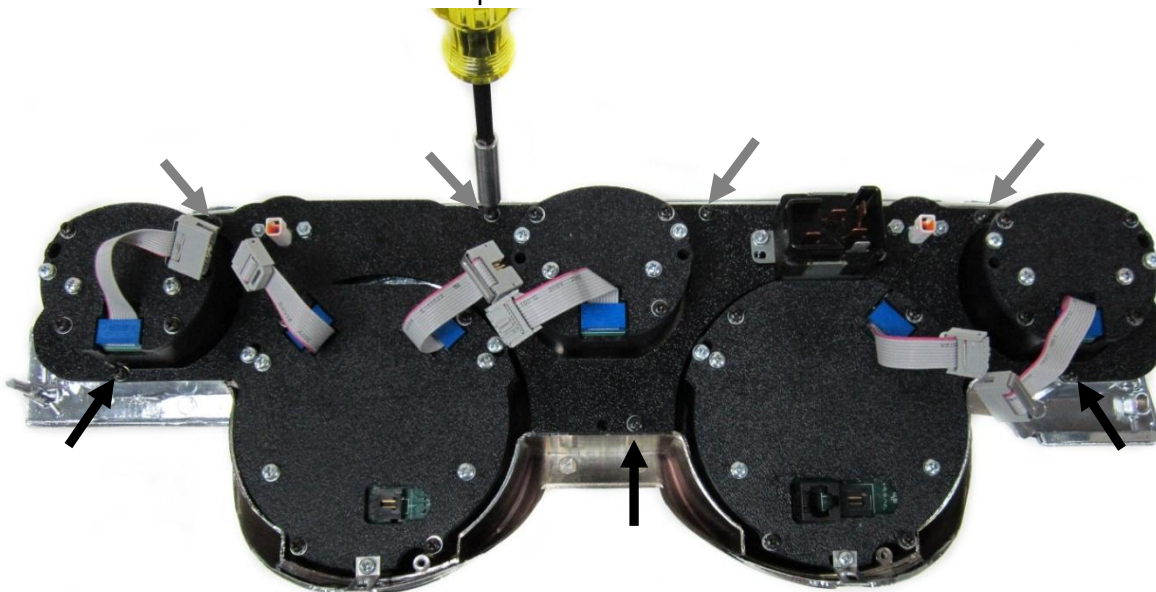

9a. Connect the flat ribbon cables. **A**

9b. Connect the two pin harnesses (white/green and white/black) to the optional blinker locations. **B**

9c. Connect the three-pin harness (red, black, blue) to the Speedometer and Tach. **C**

9d. Connect the CAT 5 cable to the Speedometer. **D**

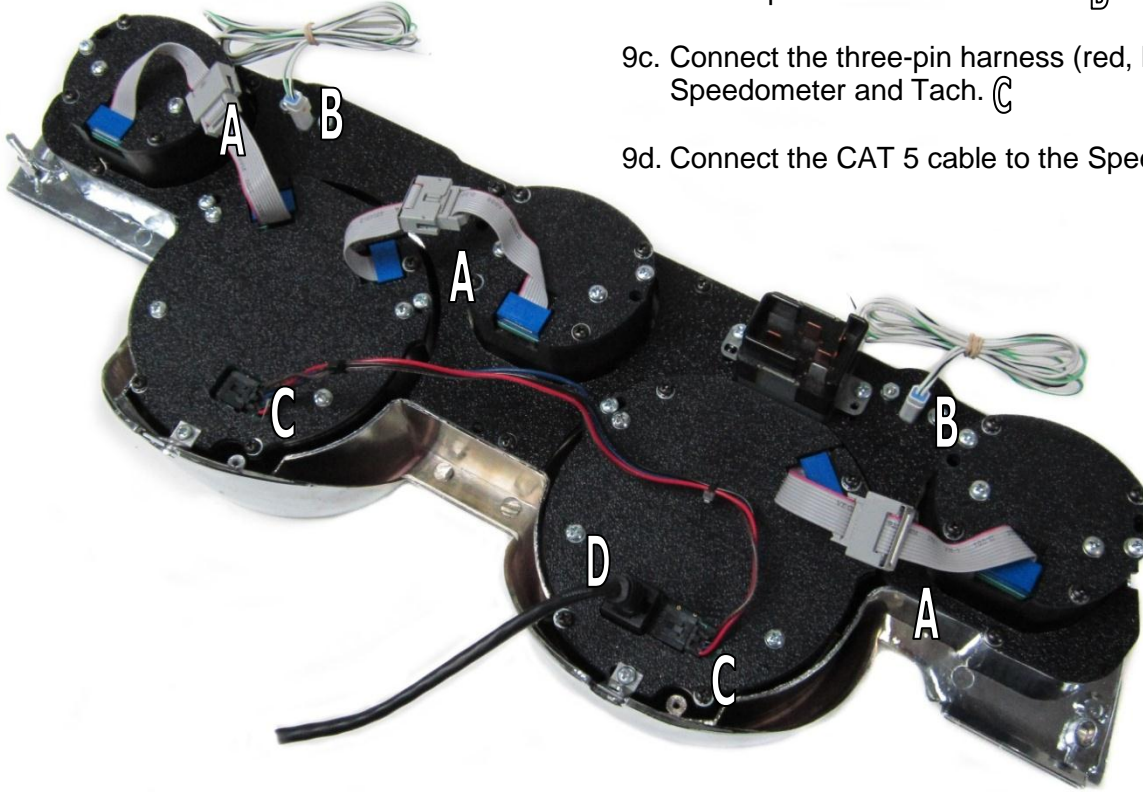

10. This system comes with two options for the turn signals in your dash. You can either have arrows located in the faceplate of your new VHX display, and/or arrows in your vehicle's stock turn signal locations. To use the new faceplate arrows, follow the wiring instructions for the turn signals found in the main VHX manual.

To optionally use the stock turn signal arrows, do not wire the turn signals to the VHX control box. Instead, use the two provided two-wire harnesses. The harnesses plug directly into connectors on the back side of your new VHX system. Connect the wires from these harnesses to your turn signal circuit and ground as shown below. Doing this will light green LED bulbs, located in the original locations of your dash panel, when turn signals are active. Make sure to check left and right to verify they are wired correctly.

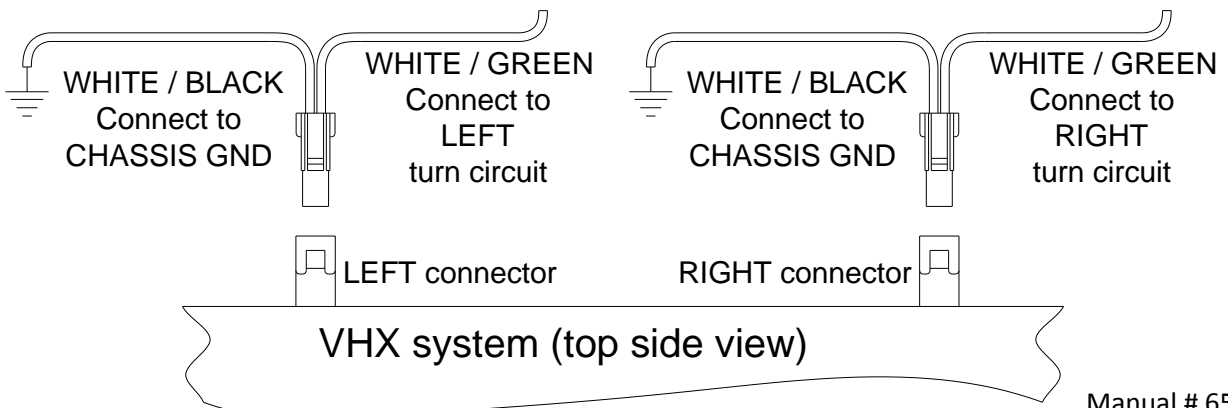



11. Use the three (3) aluminum spacers and 7/8" flat head screws from the hardware pack to secure the top portion of the bezel to the dash. From the front of the bezel, press in the spacer followed by the flat head screw to secure it in place. Note: some reproduction bezels may require sanding a flat edge on the outer most diameter to fit inside the hole.

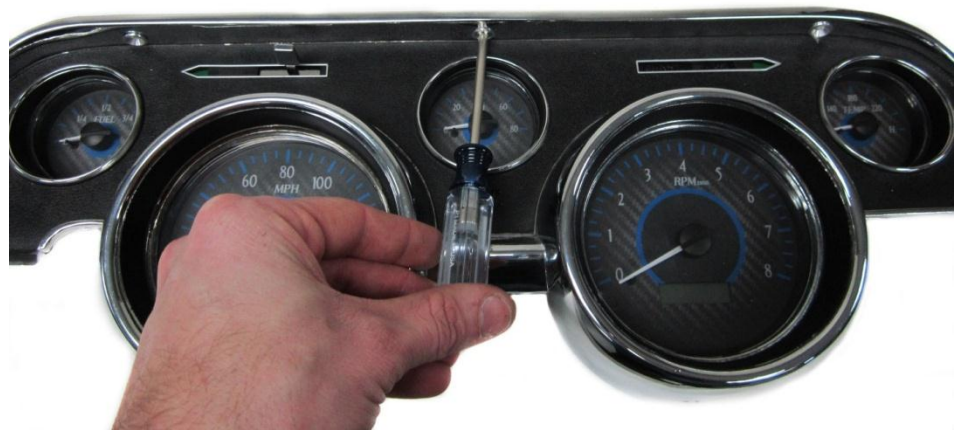

12. Use the screws from disassembly to mount the two lower points in the bezel with the aluminum brackets in place from Step 5b.

13. Refer to the main manual for wiring instructions to complete the VHX installation.



4510 W. 61<sup>st</sup> St. N., Sioux Falls SD 57107  
Phone: (605) 332-6513 Fax: (605) 339-4106  
[www.dakotadigital.com](http://www.dakotadigital.com)  
[dakotasupport@dakotadigital.com](mailto:dakotasupport@dakotadigital.com)

Manual # 650384